



Mueller Gas Products

Full-line product overview



Contents

02

Line Stopper System

03

Small Diameter Drilling & Stopping

04

Large Diameter Drilling & Stopping

05-06

Specialized Machines and Tools

07-08

Service Tees

09

Meter Valves and Bars

10

Repair Clamps

Our Mission

“ *To be a trusted provider of branded products and services known for superior quality, reliability, and the lowest total cost of ownership that help our customers operate their businesses more efficiently and protect lives and property.*

We manage our business to realize leadership, sales, and value creation over the long term. **”**

- Greg Rogowski
President, Mueller Co.

Company Overview

Since 1857, the Mueller name has been associated with superior quality flow control products. Many of our innovative products have become industry standards, including the Mueller® NO-BLO® System for working on natural gas mains and service lines.

Mueller is one of the oldest and most trusted suppliers in North America of flow control products used on metallic natural gas distribution lines, and is establishing its name for working on HDPE plastic mains as well.

Core Values

Mueller Co. has a set of Core Values to help us think, act and work together to benefit all of our stakeholders – from our employees who are our most valued assets, to our customers who expect quality products and services.

These Core Values are not an end in themselves. Rather, they form the foundation of our culture, define behaviors required of us all and guide our decision making.

As a company and as individuals, we will:

- Act with integrity – do the right thing
- Treat each other with respect
- Build relationships
- Promote a culture of innovation and continuous improvement
- Deliver exceptional results
- Foster a safe and environmentally responsible culture



NO-BLO® Line Stopping System

The Mueller® NO-BLO Line Stopping System is the preferred system for a range of installation, repair, and maintenance operations on pressurized pipelines.

The system has versatility to suit your specific needs: high or low pressure systems; bypass, double or single stops; line extensions and branch connections; and large or small lines and flow capacities. Whatever your application, Mueller has the tools and parts to get the job done efficiently and safely.

High Pressure, Two-Piece Fitting

With Mueller equipment, a section of pipe is cut inside a two-piece fitting, forming a machined cylinder. An expandable steel wedge stopper with a resilient urethane covering is locked in place. The forged steel fitting (some available rated at 1440psig/100barg/10,000kPa provides full reinforcement of the pipe in the area of the cut and retains the full pressure rating of the line.

Up to 500psig/34barg/3450 kPa

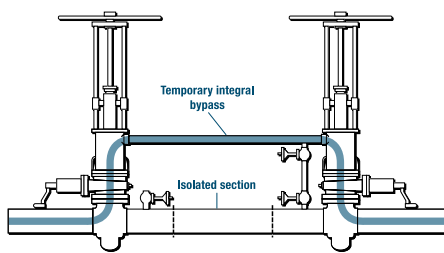

By-pass/double stop-off - up to 500psig/34barg/3450kPa

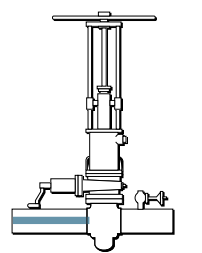

Single stop-off - up to 500psig/34barg/3450kPa

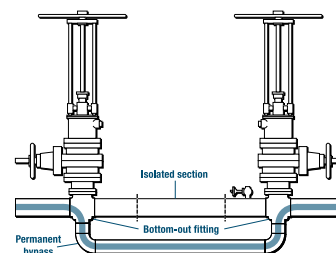

By-pass/double stop-off using bottom-out or side-out fittings - up to 500psig/34barg/3450kPa

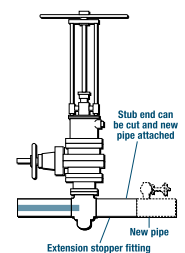
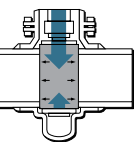

Extension stopper fitting

Low Pressure, One-Piece Fitting

For lines up to 100psig/7barg/690kPa, Mueller offers a simple one-piece fitting that requires just a drilling machine to cut the pipe, insert and lock a solid rubber stopper in place, then insert the completion plug into the stopper fitting to finish the job. This system requires cutting through only one side of the pipe. Single stop-offs and double stop-offs using a temporary bypass can be performed using this system.

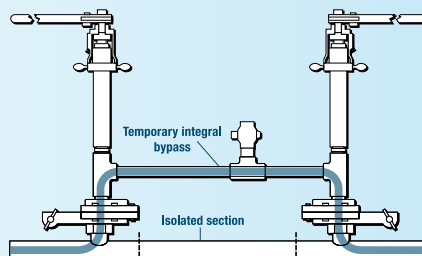

By-pass/double stop-off - up to 100psig/7barg/690kPa

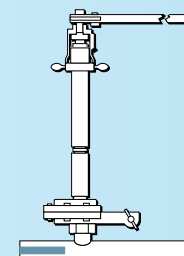

Single stop-off - up to 100psig/7barg/690kPa

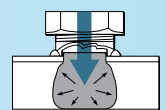

Up to 100psig/7barg/690kPa

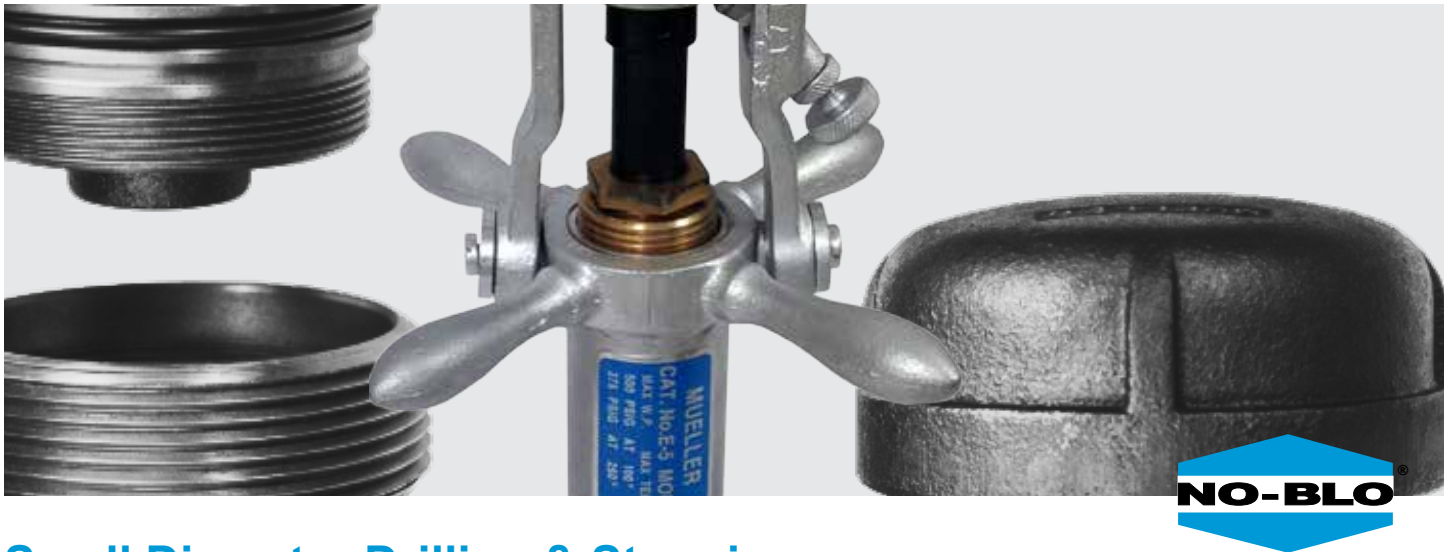

Small Diameter Drilling & Stopping

Mueller® manufactures several different small drilling and stopping machines for drilling or cutting holes $\frac{1}{8}$ " to $3\frac{3}{4}$ " (3mm to 95mm) in steel or cast iron pipe, and stopping off tees and fittings up to 4"/DN100. Machines are available in hand or power operated models with a wide selection of drills and shell cutters. These machines are part of a complete system of NO-BLO® equipment, products, and methods developed by Mueller to perform the variety of operations needed to install, extend, and maintain today's gas systems.

Small Diameter Drilling & Stopping Machines



E-5™ Drilling & Stopping Machine



EH-5™ Drilling & Stopping Machine



D-5™ Drilling & Stopping Machine



DH-5™ Drilling & Stopping Machine



No.1 Stopping Machine

Small Diameter Line Stopper Fittings



NO-BLO Low Pressure Welded Line Stopper Fitting



NO-BLO Low Pressure Mechanical Line Stopper Fitting



NO-BLO Welded Line Stopper Fitting



NO-BLO Mechanical Line Stopper Fitting



Large Diameter Drilling & Stopping

The Mueller® Line Stopper Unit Numbers 2, 3, 3SW, 3SW-500, and 4SW stopping machines are an assembly of tools and methods that provide a means to install and stop off 3” - 12” (DN80 - DN300) line stopper fittings having flanged completion caps. These line stopper units are used with Mueller’s split (two-sided) weld-type or mechanical joint-type line stopper fittings, flanged tees, and drilling nipples. Mueller also offers a Rebuild and Return Program as well as a Rental Program for its drilling and stopping machines.

Large Diameter Drilling & Stopping Machines



No. 2 Stopping Machine



No. 3 Stopping Machine

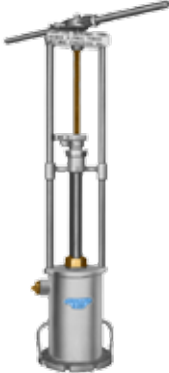

No. 3SW Stopping Machine

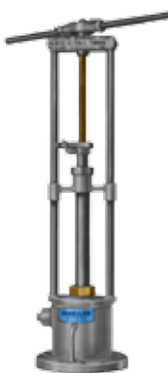

No. 3SW-500 Stopping Machine



No. 4SW Stopping Machine

Large Diameter Line Stopper Fittings



Bottom-out Line Stopper Fitting



Spherical Line Stopper Fitting



Flanged Tee

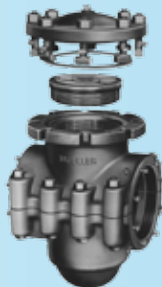

Mechanical Joint Type Line Stopper Fitting

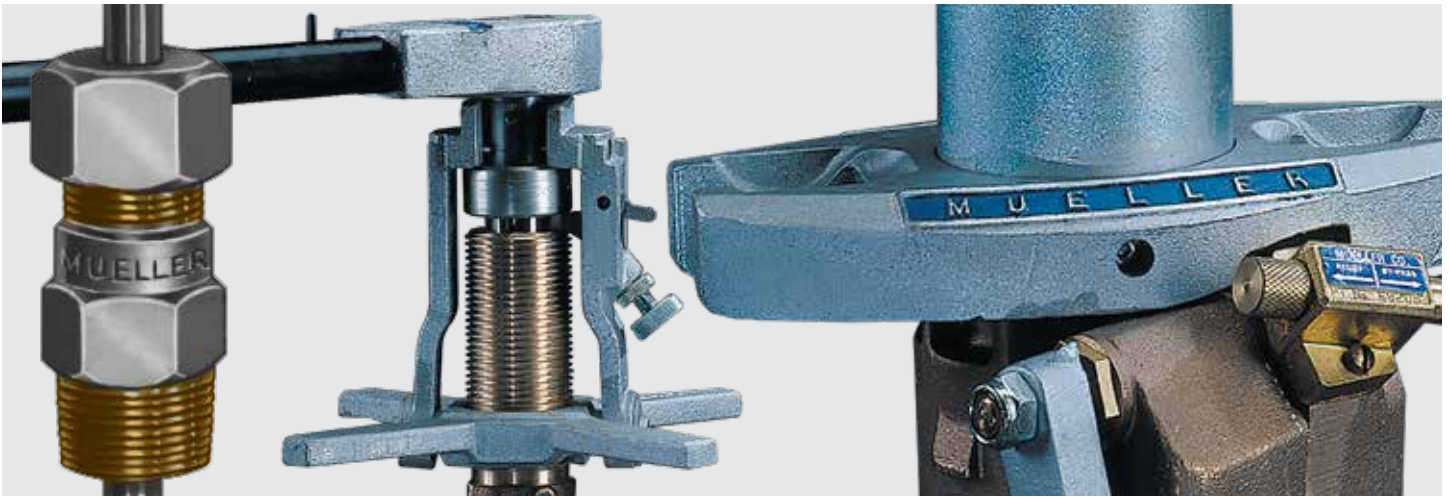

Specialized Machines and Tools

Meter Set and Maintenance Machines

The Mueller® DBS System is a portable system of tools that allows you to safely replace Gas Meters and perform a variety of other procedures, all without shutting off gas service.

The Mueller NO-BLO® Valve Changer provides a safe, effective and easy to use means for stopping Gas flow upstream of the meter valve allowing the valve to be replaced. The Mueller Valve Changer – a Mueller NO-BLO System exclusive – includes plugging units and safety clamps. It can be used on most straightway and round way meter valves in sizes ranging from ½" to 2" (DN15 to DN50), if the valve has an FIP outlet and the port through the valve will permit the passage of the Valve Changer's plugging unit.



Mueller DBS System



Mueller NO-BLO Gas Meter Valve Changer

Cast Iron Tapping Machines

The Mueller® B-101 and A-3 drilling and tapping machines are the industry standard for drilling and tapping cast iron, ductile iron, and steel Gas mains from 2" to 48" (DN50 to DN1200) in size. Both can drill and tap holes up to 2½"/DN65. The B-101 will drill and tap cast iron and steel Gas mains from 2" to 48" (DN50 to DN1200) and the A-3 can drill and tap Gas mains from 4" to 48" (DN100 to DN1200). The NO-BLO® System allows for the removal of a coupon from the main for inspection, and insertion of a threaded plug, also while maintaining full control over the flow. Both can be power-operated or manually-operated.



B-101™ Drilling and Tapping Machine



A-3™ Drilling and Tapping Machine

Service Tee Maintenance Tools

The H-17040 Service Tee Stopping Machine is a small, lightweight, hand-operated machine used to stop off ¾", 1" & 1½" (DN20, DN25 & DN32) NO-BLO Service Tees. The H-17045 & H-17145 are small, direct, hand-operated machines designed for inserting & extracting plugs and bushings when used on certain Mueller NO-BLO Tees, Service Line Stopper Fittings & Drilling Nipples.

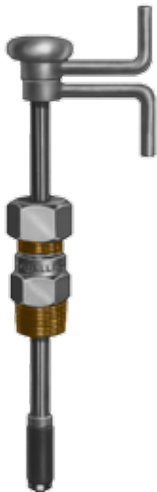

H-17040 Service Tee Stopping Machine



H-17045 Completion Machine



H-17145 High-Pressure Completion Machine



Service Tees

NO-BLO® Service Tees

Mueller® NO-BLO Service Tees are an economical choice for quick, easy installation with standard Mueller NO-BLO machines and equipment. Service Tees are available with either weld or external (M.I.P.) thread inlets. Outlets include weld, threaded (M.I.P. or F.I.P.) and compression connections.



Typical Service Tee
Cut-Away



Service Tee
(Welded x Welded)

NO-BLO Service Stop Tees

Mueller NO-BLO Service Stop Tees are used to make a main to service connection. These Service Stop Tees have a mechanism that can be used to shut off the flow of gas in the service line. The mechanism makes a metal-to-metal seat in both the fully open and fully closed position to assure positive sealing. This mechanism has differential threads which develop powerful seating forces.



Typical Service Stop Tee
Cut-Away



Service Stop Tee
(Welded x M.I.P.)

NO-BLO® Curb Stop Tees

Mueller® Curb Stop Tees are used to make main-to-service connections and also offer a means to control service line flow at the main. Mueller Curb Stop Tees can be used with curb boxes to access the buried tee from above ground and also have a large operating head that is drilled to accept the attachment of a shut-off rod.



Typical Curb Stop Tee
Cut-Away



Curb Stop Tee
(M.I.P. x Extended Weld)

AUTOPERF® Service Tees

Mueller AUTOPERF Tees provide a fast economical way to make a main-to-service connection. They feature a self-contained perforator that uses the Mueller NO-BLO® method to cut a hole in the main to initiate gas flow into the service line, eliminating the need for drilling machines.



Typical AUTOPERF
Service Tee Cut-Away



AUTOPERF Service Tee
(Welded x Mueller 112® Tip)

Mueller AUTOPERF Tools

The AUTOPERF operating wrench is used to perforate holes in mains under pressure. The AUTOPERF tool seals the top of the tee, allowing the entire operation to be completed with no loss of gas. It is available with or without a ratchet handle.

The AUTOPERF crimping tool is used to form the top of the tee body for a pressure-tight, metal-to-metal seal between the body and the perforator.



AUTOPERF Operating Wrench



AUTOPERF Crimping Tool

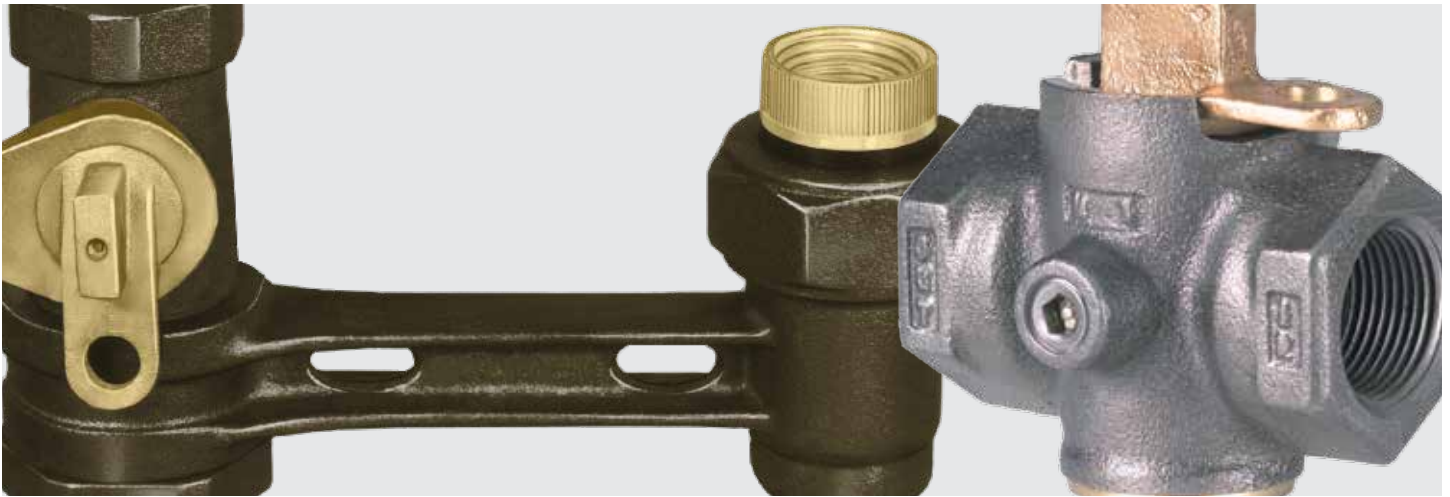

Mueller® Meter Valves and Bars

Mueller manufactures a complete line of quality gas meter valves and bars in many styles. Meter valves are available in Ball, Relubricatable Plug and By-Pass configurations.

Meter bars are offered in sizes $\frac{3}{4}$ " , 1" & $1\frac{1}{4}$ " (DN20, DN25 & DN32) with numerous options from single bar configurations to complete meter manifold connections.



Mueller Complete Meter Manifold Connection



Mueller Meter Bar



Mueller Meter Valves



Brisco™ Bypass Meter Valves

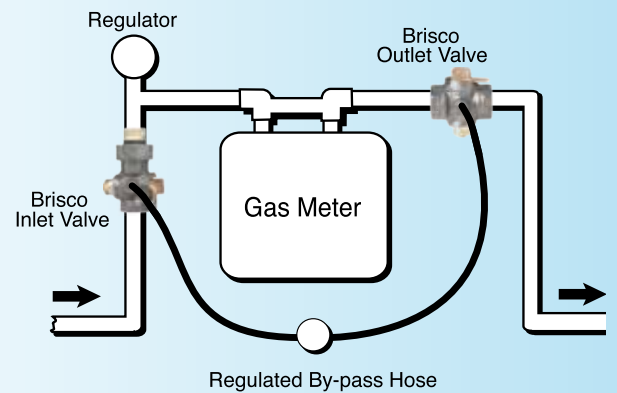



Repair Clamps

Pipe Repair Clamps are a great choice for emergency repair of main or service line breaks. These repair clamps can be installed quickly & economically to temporarily repair damaged steel or cast iron pipe. We offer many styles to choose from including stainless steel options and low profile designs.

Ductile Iron Service Saddles are available, providing a tight connection between main and service line. These service saddles feature an O-ring fit into a dimensionally-controlled groove which eliminates creep and seal blowout.



Stainless Steel Repair Clamps



Mini-Band™ Clamps



Pipe-Saver® Clamps



Ductile Iron Service Saddle



Delivery and Service

The capacity to deliver the widest array of products and stand behind those products to ensure your satisfaction is our strength. The success of Mueller is dependent upon the success of those who are involved, both inside and outside our company. Therefore, we feel our future is wholly-dependent on long-term relationships with our employees, customers and suppliers. This is why we strive to be proactive and responsive to your needs, always looking for a “better way”. It’s an approach that has set us apart since 1857 and will assure our mutual achievement and prosperity in the future.

Mueller sales representatives, strategically located around the world, are always ready to provide application and installation assistance and help with any special requirements.



Foster a Safe and Environmentally Responsible Culture

Protecting the health and safety of our employees is essential. We implement effective and responsible work processes and procedures based on industry best practices. We strive to be good stewards of the environment in the way we conduct our business.

Fostering a Safe and Environmentally Responsible Culture means:

- Think of safety, quality and environmental stewardship as a way of life
- Achieve higher safety goals and provide ongoing safety education and training
- Be aware of safety hazards, implement incident prevention strategies to resolve them and regularly evaluate safety and environmental activities
- Adhere to a workplace free from violence, illegal drugs and the inappropriate use of alcohol
- Improve our environmental performance and the communities we serve as environmental stewards, working to conserve valuable natural resources

Follow Us:



For more information about Mueller or to view Mueller’s full line of Gas products, please visit www.muellergas.com or call one of the numbers as listed below.



North America
633 Chestnut St., Suite 1200
Chattanooga, TN 37450 USA
Toll Free: 1.800.798.3131
www.muellergas.com
moreinfo@muellercompany.com

International Division
Customer Service: +1 432 490 9555
EMEA: +44 1438 487410
Latin America: +54 911 6939 2697
Singapore: +65 663 18 999
www.mueller-international.com
International@muellercompany.com

Copyright © 2015 Mueller Co., LLC. All Rights Reserved.

The trademarks, logos and service marks displayed in this document herein are the property of Mueller Co., LLC, its affiliates or other third parties. Products above marked with a section symbol (§) are subject to patents or patent applications. For details, visit www.mwppat.com.

Form 12969 - Rev 4/15